

# 2 W3 60, 80

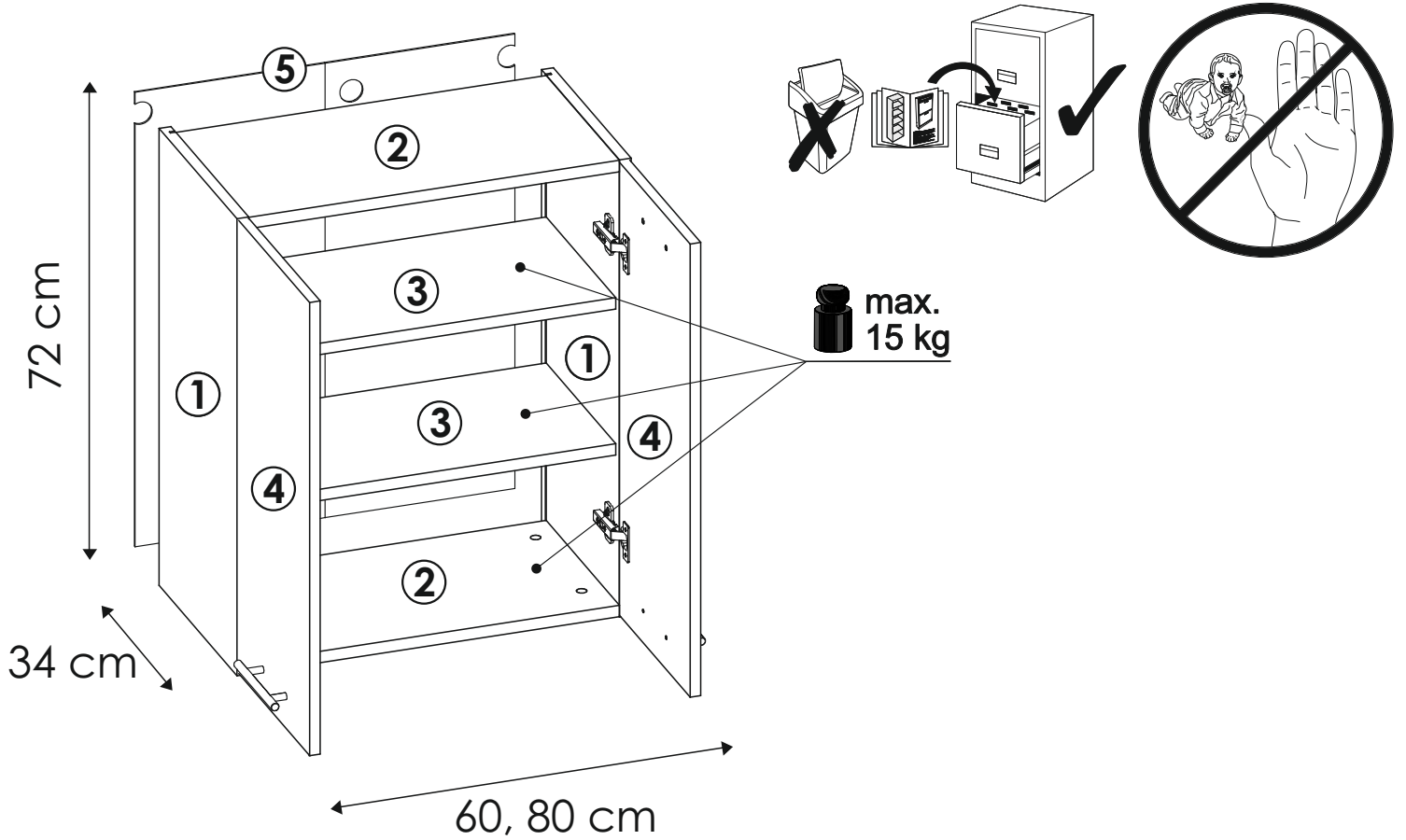

<b>a1</b>  8x35 x....(x8)	<b>bc0</b>  x....(x4)	<b>bc1</b>  x....(x4)	<b>c1</b>  Euro 4x13 x....(x8)	<b>d2</b>  x....(x8)	<b>e0</b>  x....(x8)	<b>e1</b>  x....(x8)	<b>f1</b>  x....(x8)	
<b>h1</b>  x....(x2)	<b>i5</b>  3,5x30 x....(x4)	<b>k3</b>  4x22 x....(x4)	<b>m</b>  x....(x1)	<b>n1</b>  3x16 x....(x20)	<b>p01</b>  x....(x4)	<b>p8</b>  x....(x1)	<b>r4</b>  x....(x6)	<b>w16</b>  x....(x1)

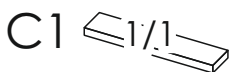

- ① -C1
- ② -C1
- ③ -C1
- ④ -C1
- ⑤ -C1

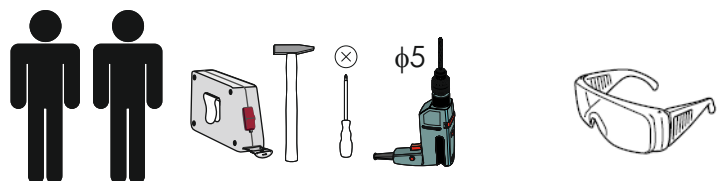
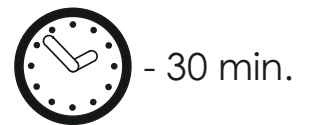

1

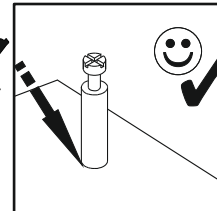
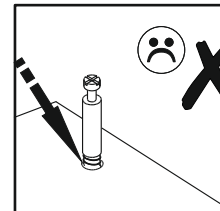
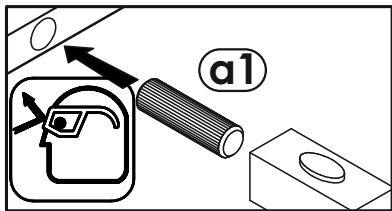
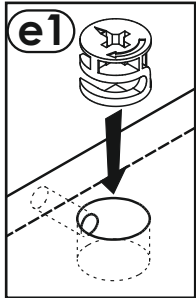
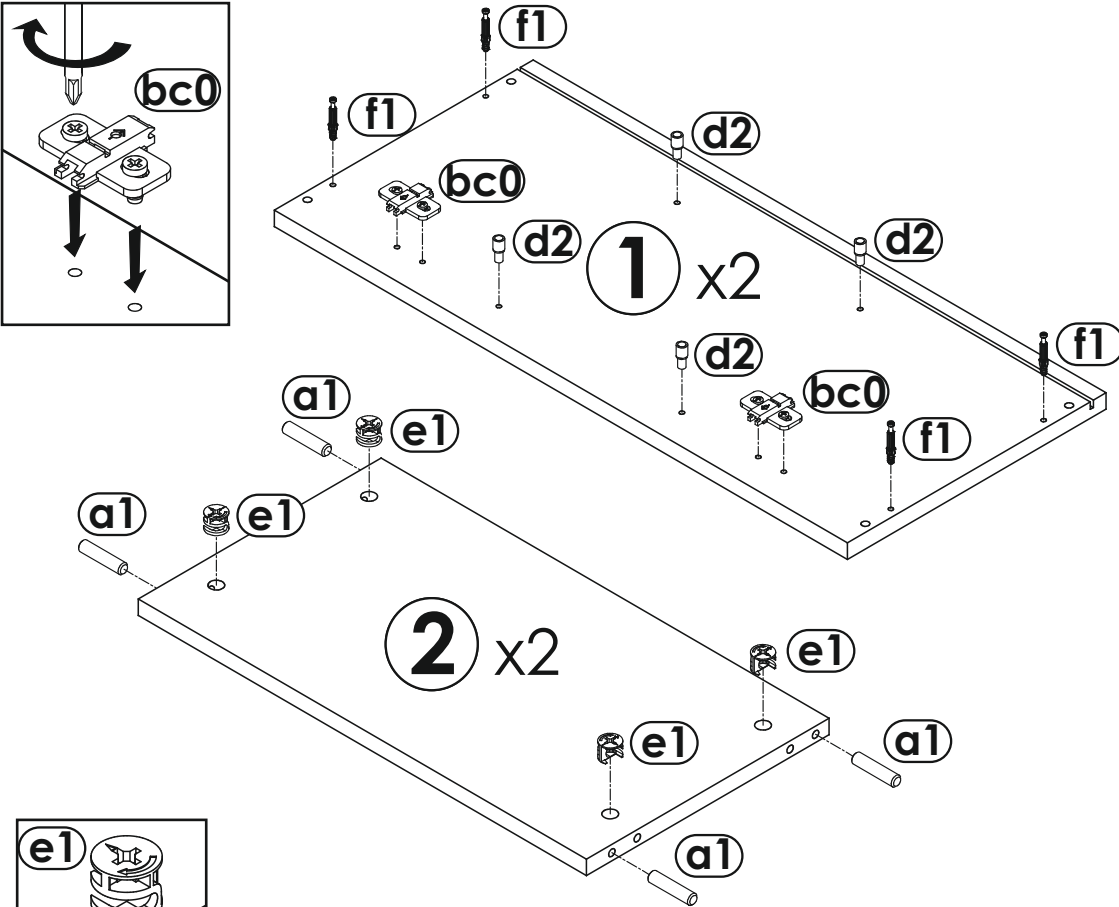
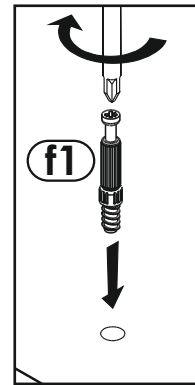
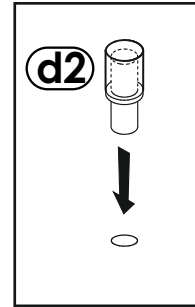
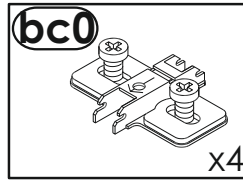
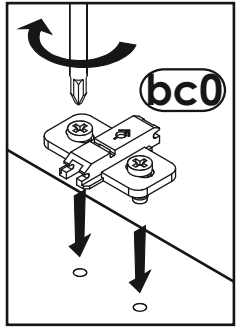
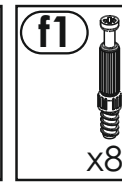
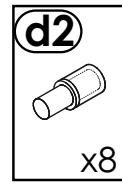
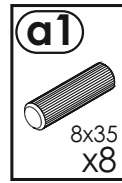
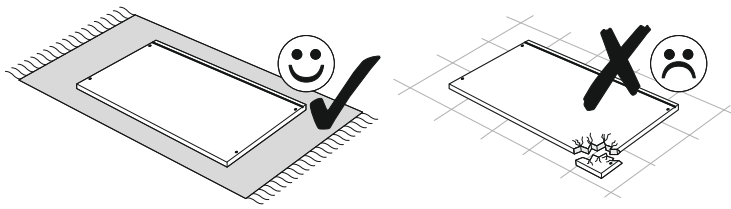

2

